



SIMULATED TRUE DIVIDED LINES.....	4
EXTERIOR GRID.....	5
DUAL GLAZING.....	6
SCROLL / SQUARE PANNING	7
WRAP AROUND PANNING / RECEPTOR SYSTEM	8

EFCO reserves the right to change configurations without prior notice when deemed necessary for product improvement. For specific product applications, consult your EFCO representative.



Simulated True Divided Lites

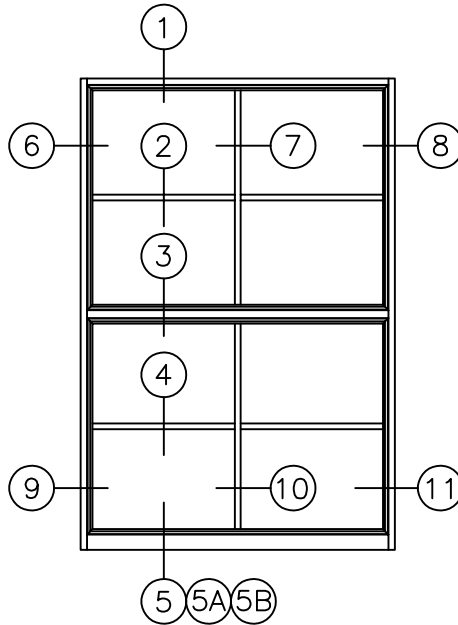

Typical Elevation

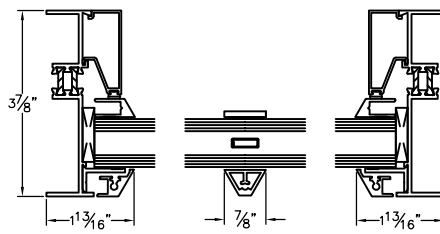
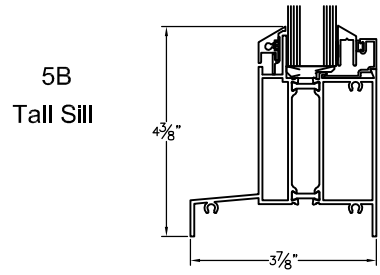
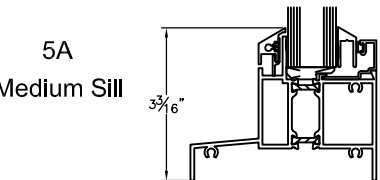
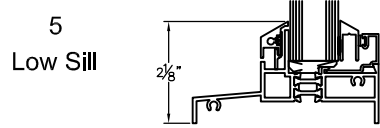
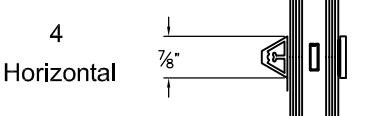
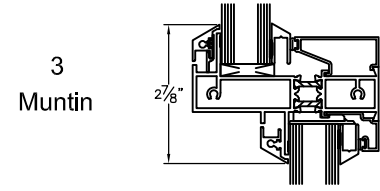
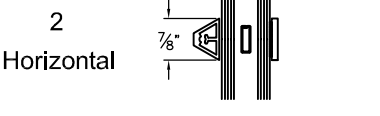
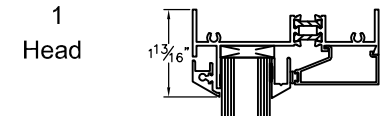

6 Jamb 7 Vertical 8 Jamb

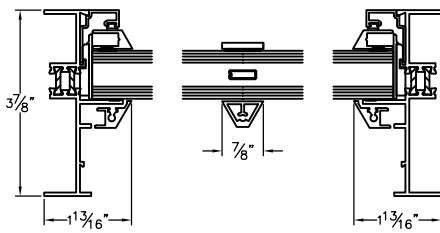

9 Jamb 10 Vertical 11 Jamb



Exterior Grid

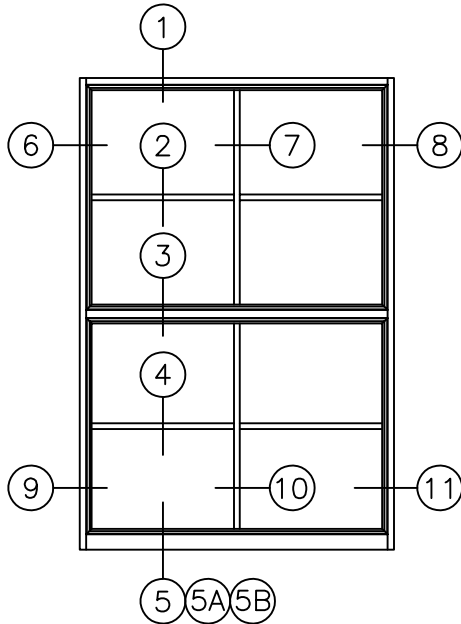

Typical Elevation

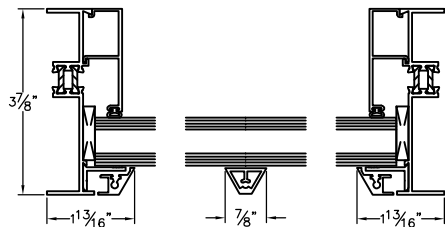
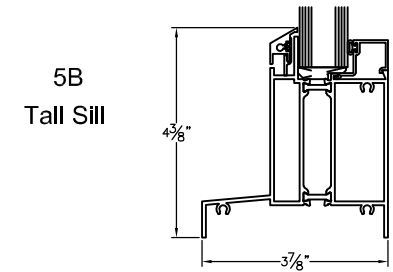
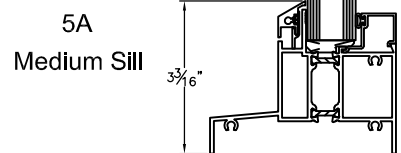
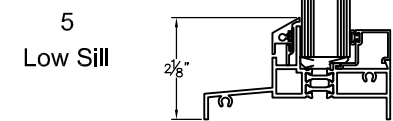
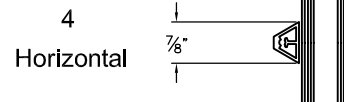
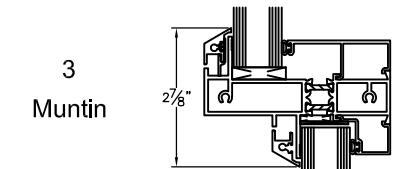
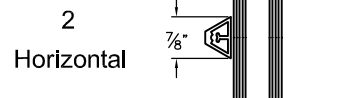
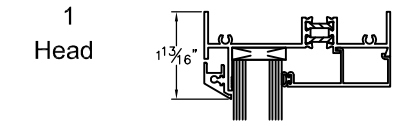

6 Jamb 7 Vertical 8 Jamb

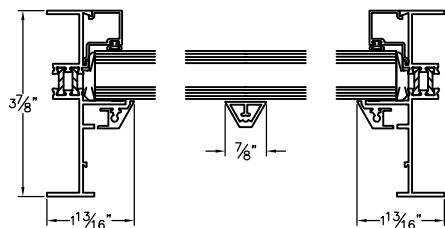

9 Jamb 10 Vertical 11 Jamb



6715 Hung Replica Dual-Glazing w/ 5/8" Blinds

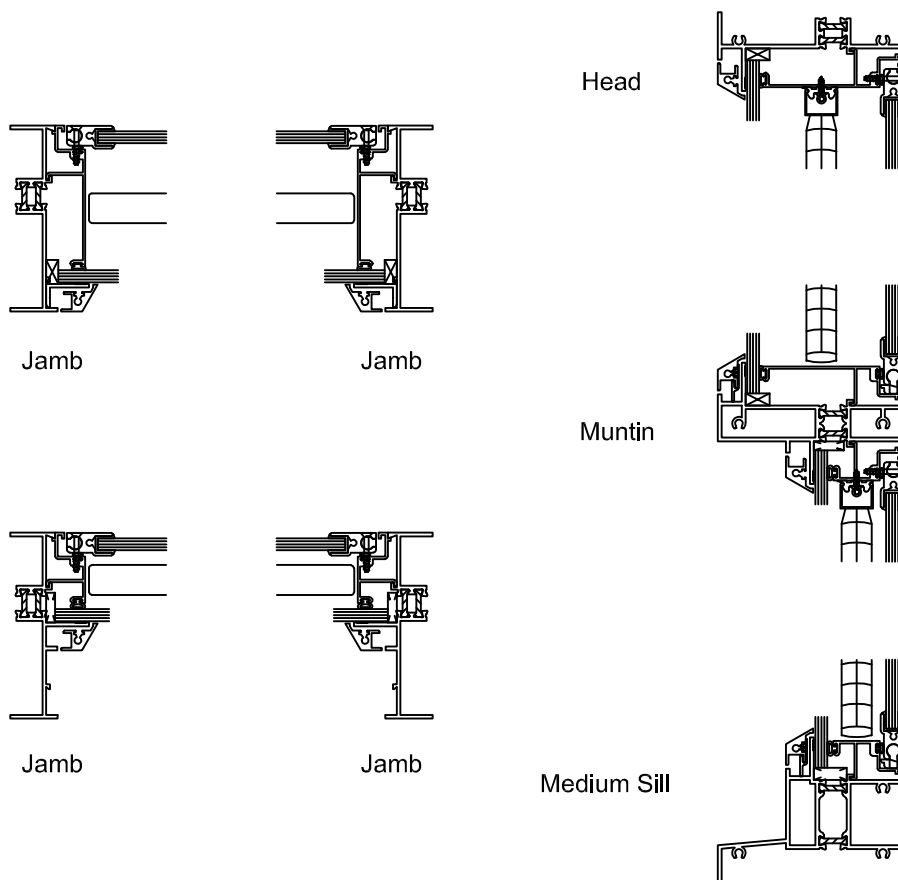



Scroll Panning

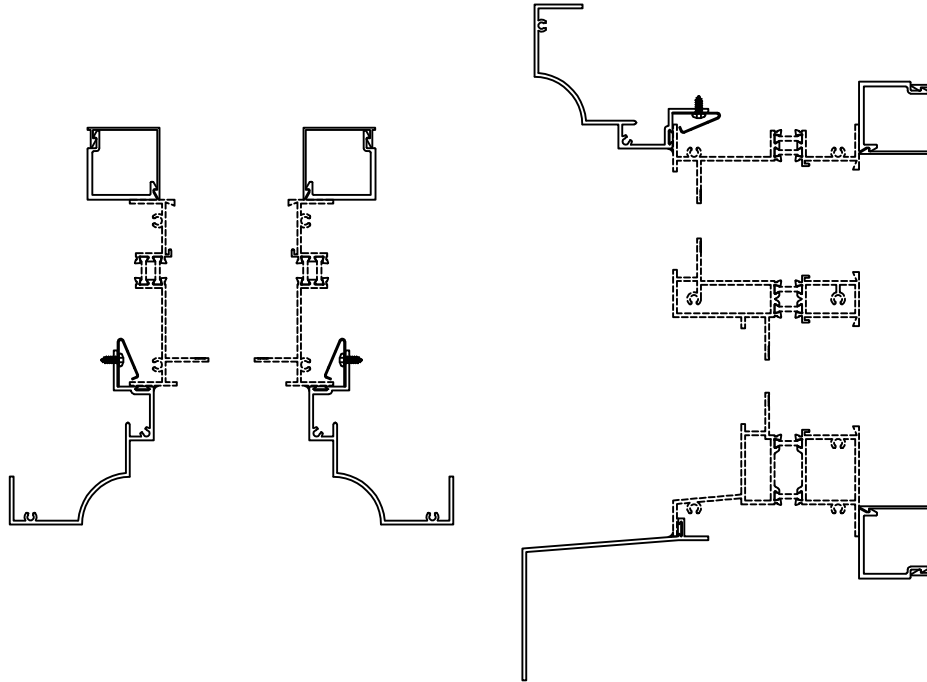

Square Panning

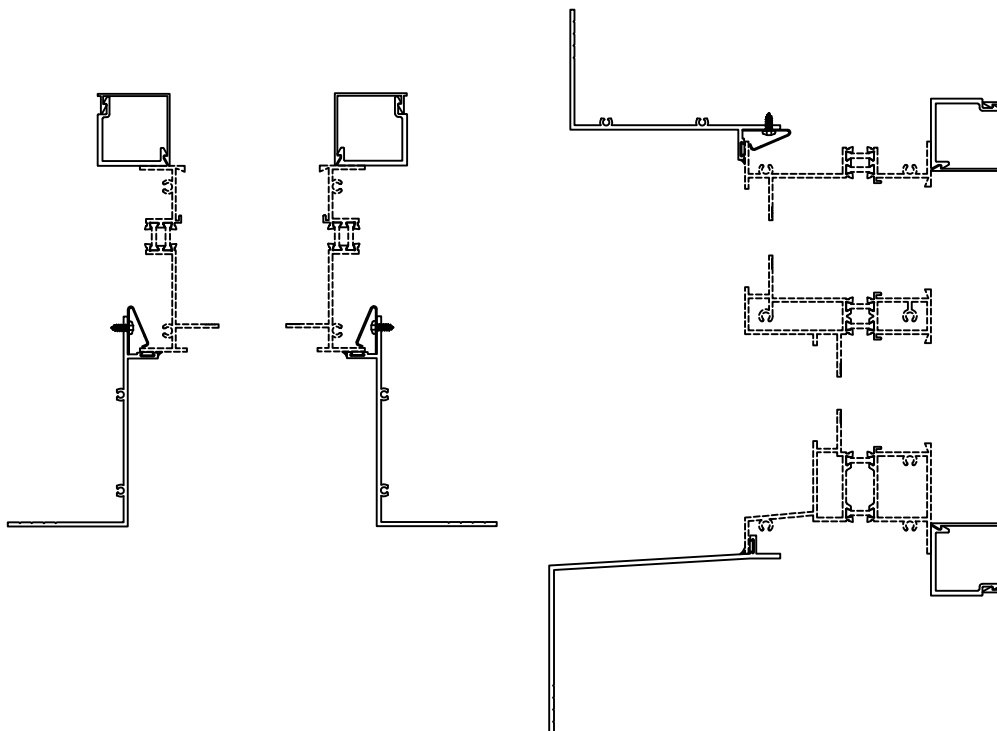



Wrap Around Panning

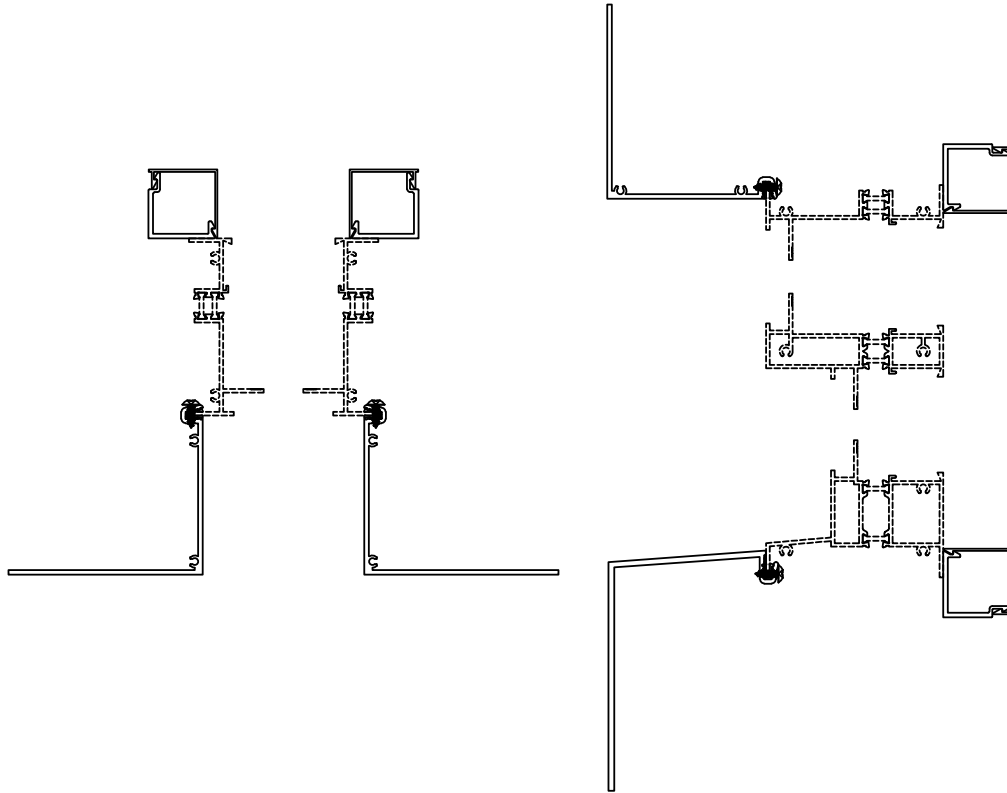

Subframe/Receptor System

