

300 STILE
S/A D200 FOR OFFSET
PIVOT BUTT HINGE

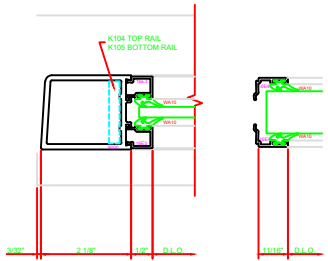

400 MEETING RAIL
D200

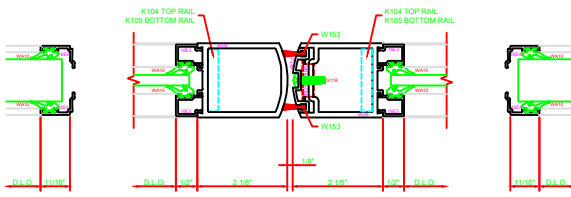

305 STILE
S/A D200 FOR OFFSET
PIVOT BUTT HINGE

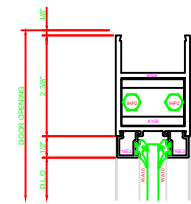
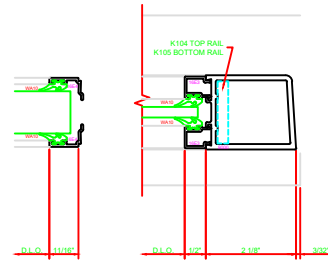

100 TOP RAIL
S/A D200

ERASE NOTE:
TOP RAIL FOR SURFACE CLOSERS OR
DORMA TYPE C.O.C. NOT LON C.O.C.

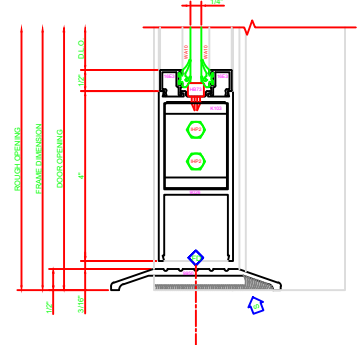
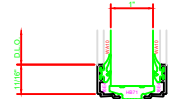
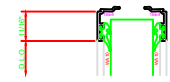

200 BOTTOM RAIL
S/A D200